

Technical Brochure

LTG Air Diffusers

Floor Swirl Diffusers ILB

intelligent
industry



Large air flow rates, for assembly halls

Technical brochure • Floor Swirl Diffusers ILB

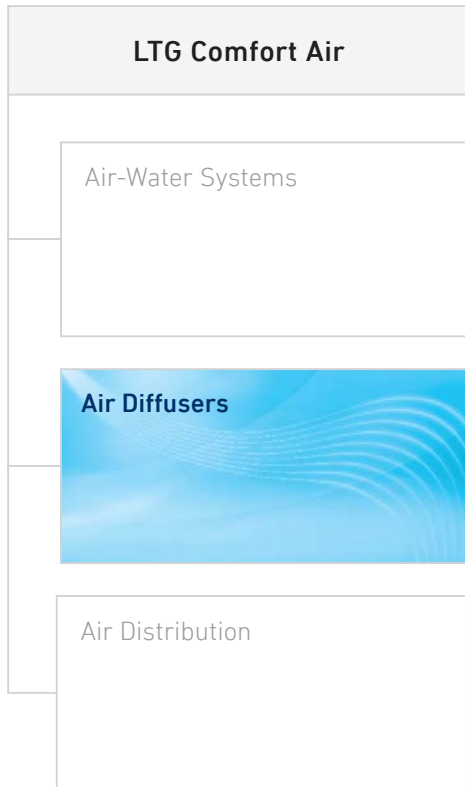

Content

	Page
General description	3
Dimensions	5
Technical data	6
Nomenclature, ordering code	7

Notes

Dimensions stated in this brochure are in mm.

Dimensions stated in this brochure are subject to General Tolerances according to DIN ISO 2768-vL.

The surface finish is designed to meet the requirements for applications in buildings - room climate according to DIN 1946 part 2. Other requirements on request.

The actual tender documentations are available in word format at your local dealership or at www.LTG.net.

LTG planning tools – we support you!

Visit the **download area on our website www.LTG.net** with helpful tools, such as dimensioning programs, streaming videos and product information!

Also available: Our product overviews about air diffusers, air-water systems and air distribution products.

DOWNLOADS

ProductNavigator & DocumentFinder



ProductNavigator
Please choose your desired product.



DocumentFinder
Please choose your desired type of documents.

Technical brochure • Floor Swirl Diffusers ILB

View of unit



Design

Each diffuser is equipped with a basket and adjustable damper. Damper settings are adjustable in steps of approximately 20 % airflow. This is especially beneficial in tiered seating applications, as rear seating typically requires approximately 20 % more airflow due to the stratified layer of heat engulfing elevated seats,

With basket BA1

For assembly halls with non-critical acoustical criteria, such as lecture theatres.

With basket BA2

For acoustically stringent assembly halls, such as opera houses.

Application

Air supply from beneath auditorium seats.

Installation example

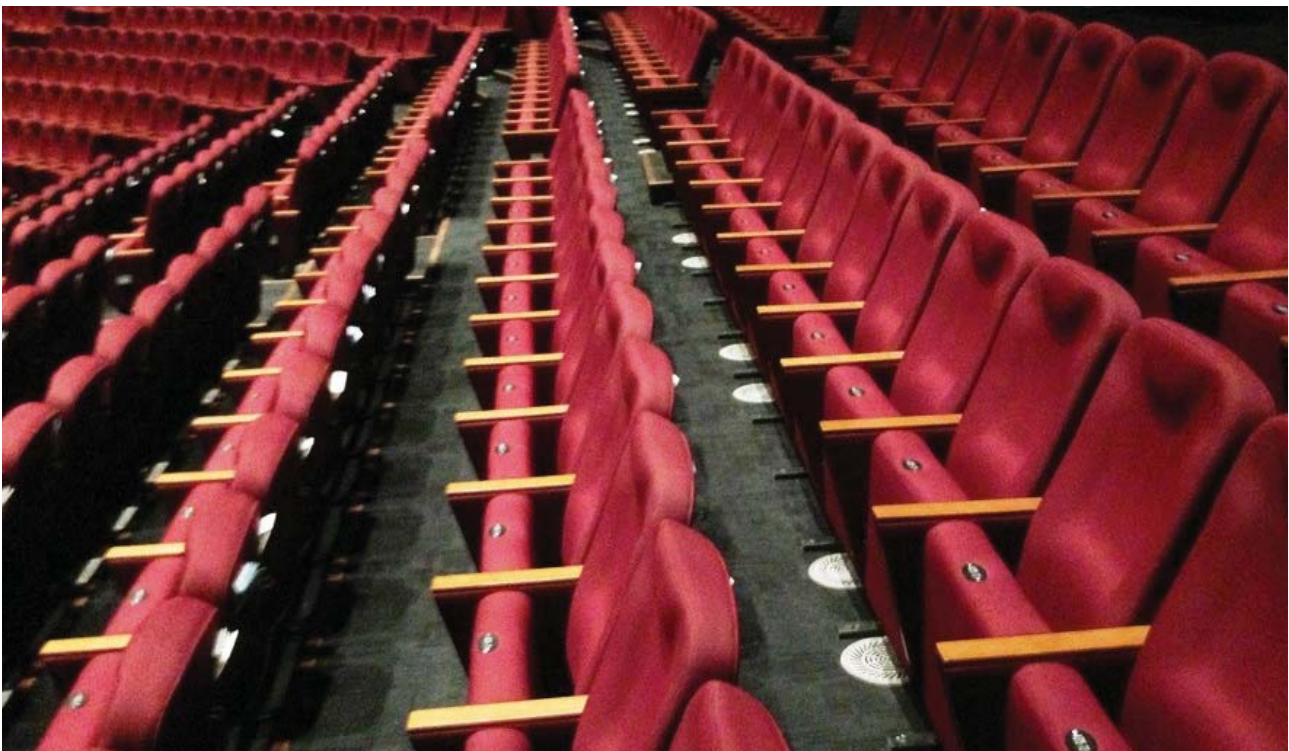

Installation example: Calvary Convention Centre, Malaysia

Technical brochure • Floor Swirl Diffusers ILB

Mode of operation

The highly inductive supply air pattern strongly induces surrounding room air into the supply air stream, equalising supply air stream temperature with room air temperature and breaking down discharge velocity. This provides draught-free air supply, in which air temperature at ankle height does not drop below the desirable 21 °C.



The discharge direction is inclined towards the rear – away from the sensitive ankle regions of seated occupants. The incline direction can be rotated to allow for applications where the diffuser is not directly centrally located beneath the seat, whereas front seating typically requires 20% less airflow than the average, due to gentle cascading of additional cool air from higher tiers.

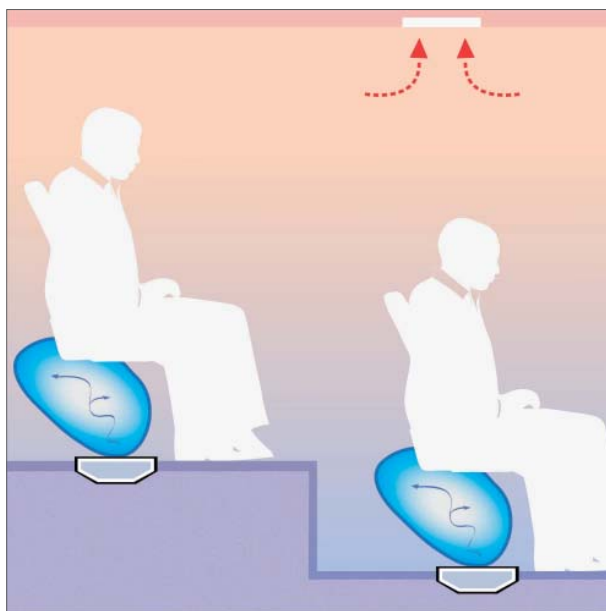

The ILB provides substantially equal horizontal temperature distribution with a minimal vertical temperature gradient typically less than 1.5 K/m in the occupied space. Room air velocities are extremely low. Heat and contaminants rise by natural convection to accumulate in high level.

Typical supply airflow is between 10...20 L/s at 16...18 °C. Low-level air distribution systems, combined with high-level extraction, improve levels of comfort and air freshness by supplying conditioned air directly to the lower levels of the occupied space.

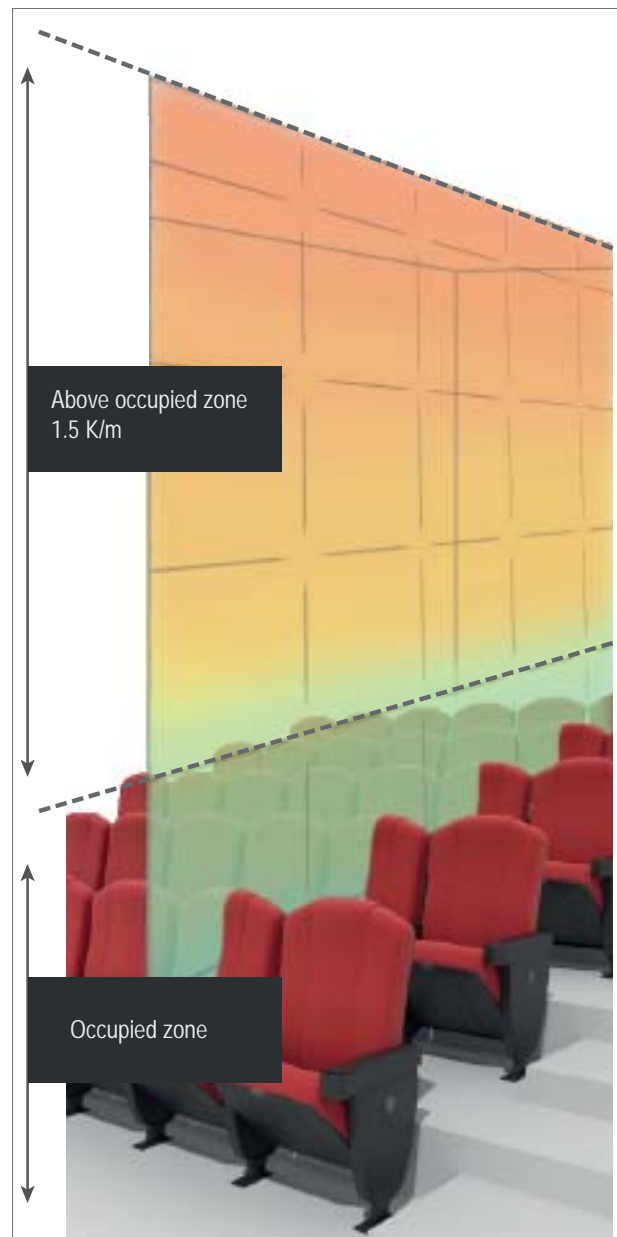

Technical brochure • Floor Swirl Diffusers ILB

Dimensions with basket BA1

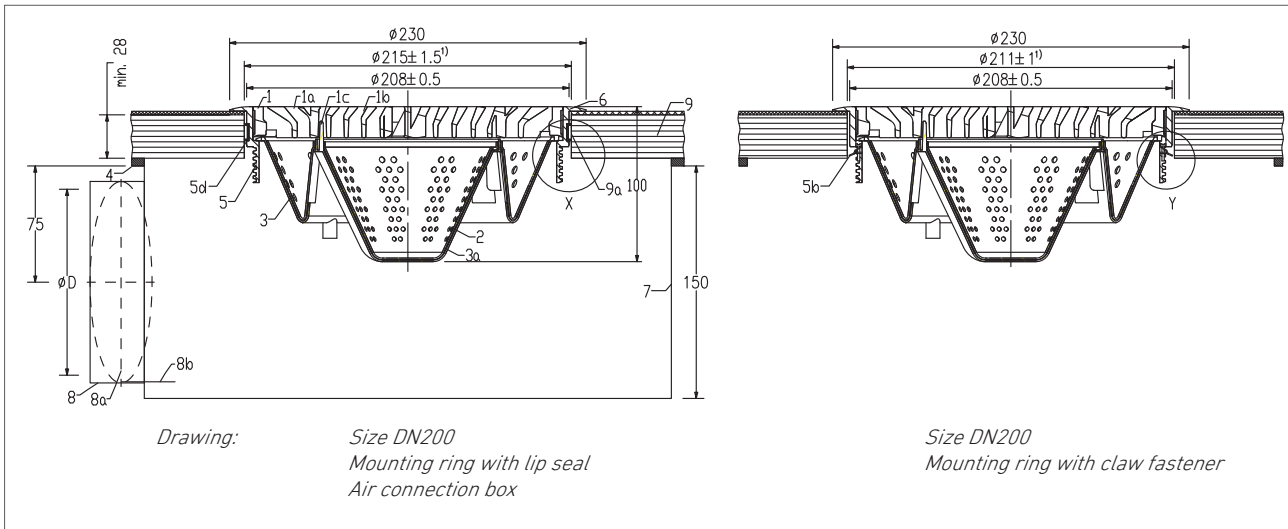

Dimensions with basket BA2

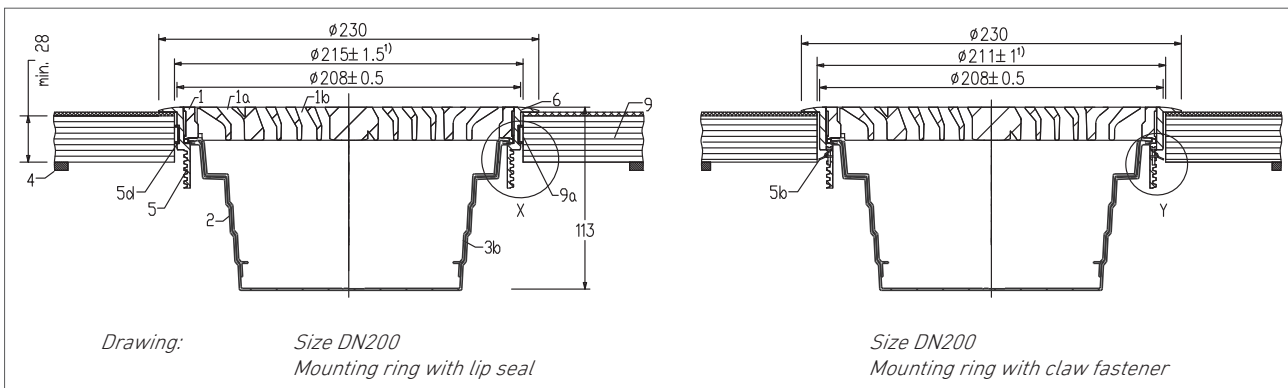

1) Ø of floor penetration

- 1 Swirl discharge element (core)
- 1a Swirl discharge slots
- 1b Diagonal discharge slots
- 1c Indicator
- 1d Symbols for configurations
- 1e Pointer for flow direction
- 2 Basket
- 3 Outer damper (basket BA1)
- 3a Inner damper (basket BA1)
- 3b Damper (basket BA2)
- 4 Sealant (on site, by others)
- 5 Mounting ring insert
- 5b Claw fastener
- 5d Lip seal
- 6 Trim lip
- 7 Connection box
- 8 Connection spigot
- 8a V-damper
- 8b Lever
- 9 Access floor tile
- 9a Floor penetration

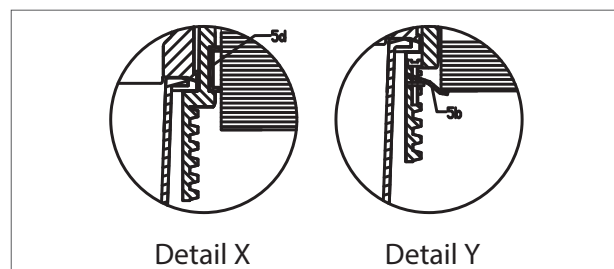

Technical brochure • Floor Swirl Diffusers ILB

Technical data

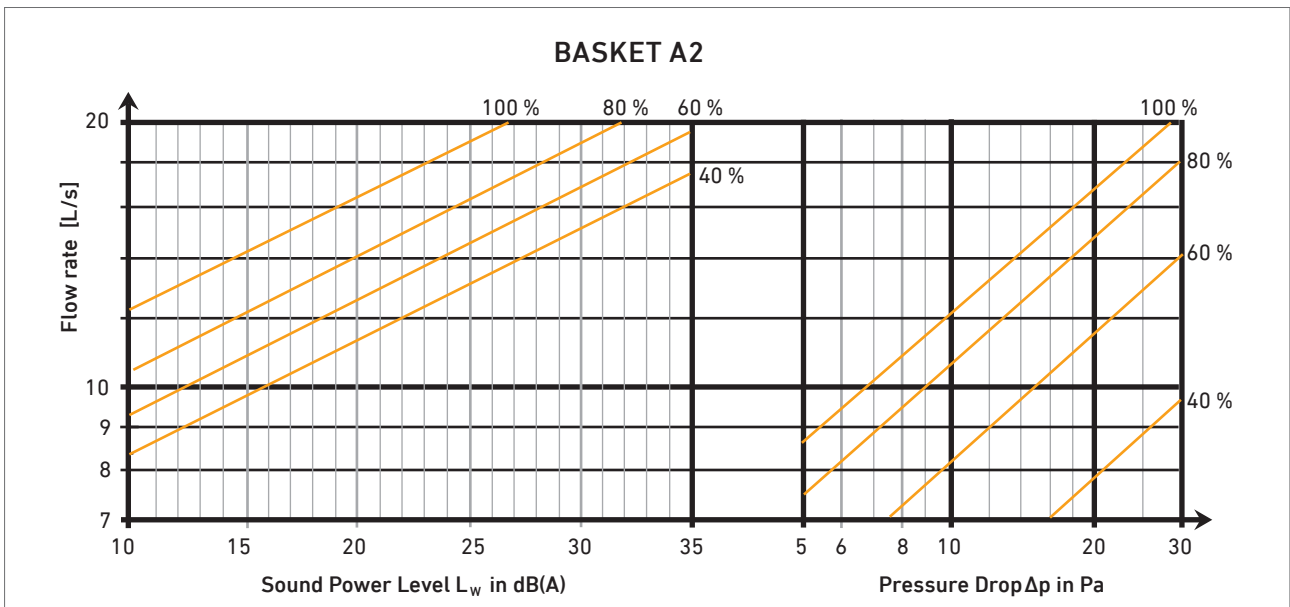
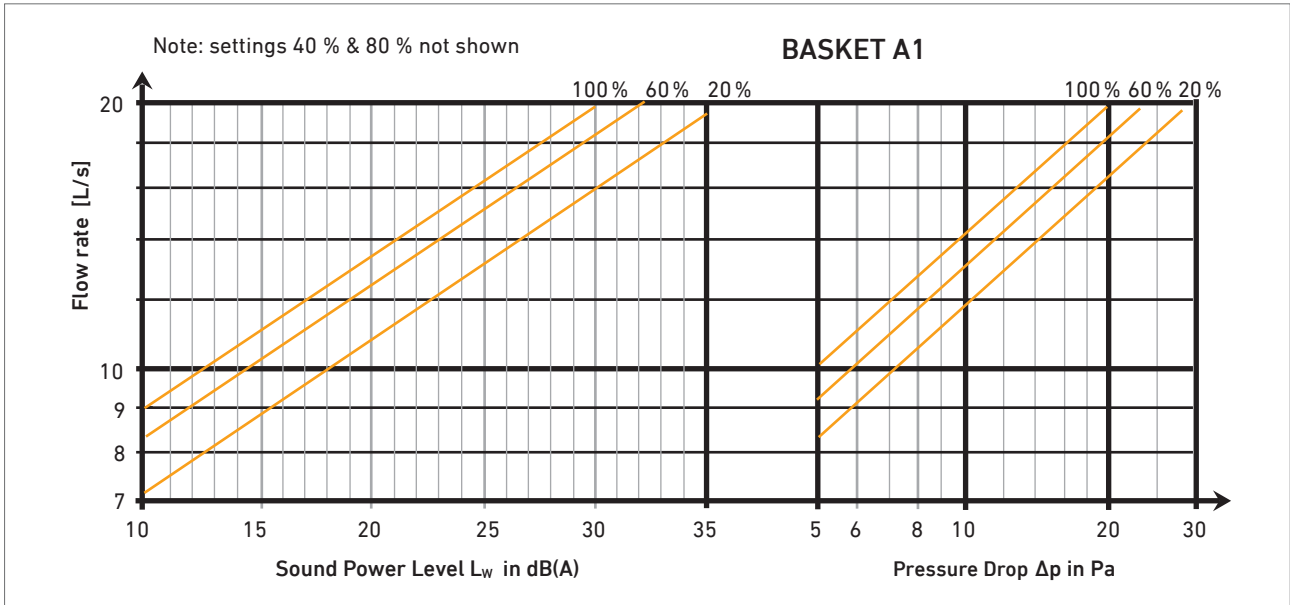

Technical brochure • Floor Swirl Diffusers ILB

Nomenclature, ordering code

ILB / P / 200 / S / BA1 / DO / RR / ST / O
 (1) (2) (3) (4) (5) (6) (7) (8) (9)

(1) Series	ILB	= Floor swirl diffuser ILB
(2) Material	P	= Polycarbonate (standard)
	A	= Aluminium
(3) Size	200	= DN 200
(4) Adjustment	S	= no jet adjustment (standard)
	H	= manual jet adjustment
	M	= motor-driven jet adjustment
(5) Basket ¹⁾	BA1	= Assembly hall basket - high ³⁾ (standard)
	BA2	= Auditorium basket - high ³⁾ (quiet operation)
	O	= no basket
(6) Damper ²⁾	D1 ⁵⁾	= with damper ³⁾ (standard),
	DO	= no damper
(7) Mounting ring	RR	= Mounting ring with lip seal (standard)
	RC	= Mounting ring with claw fastener ⁴⁾
	RO	= no mounting ring
(8) Colour	ST	= Standard grey/alu unpainted (standard)
	= RAL (digit colour code)
(9) Air connection box	O	= no air connection box (standard)
	K	= with air connection box

1) Only with mounting ring

2) Only with basket

3) 100 % for basket BA1, 80 % for BA2, other settings available on request.

4) Only with aluminium mounting ring







5) Damper pre-set; swirl discharge element, basket and mounting ring unassembled

Product Overview • LTG Air Diffusers

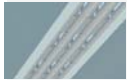
LTG Air Diffusers for ceiling, wall or floor

	Ceiling	Wall	Floor
Linear diffuser	 LDB	 LW <i>module</i>	 LDU and LDU-W
Swirl diffusers	 DLA	_____	_____
Transfer air device	_____	 LDO-T	_____

Custom Diffusers

	Circular diffuser LDR for curved design solutions
	Linear diffuser LDB 12/M for railway technology
	Ceiling jet diffusers DSA/MSA
	Linear diffuser LDB <i>home</i> for controlled home ventilation
	Industrial diffuser ILQ <i>sf</i> for demand-controlled ventilation
	Displacement air diffuser ILD for halls
	Displacement air diffuser BLQ for integration into steps

Engineering Services

	LTG Engineering Services Comfort Air Technology
---	---



**AIR TECH
SYSTEMS**

Comfort Air Technology

Air-Water Systems
Air Diffusers
Air Distribution

Process Air Technology

Fans
Filtration Technology
Humidification Technology

Engineering Services

Laboratory Test & Experiment
Field Measurement & Optimisation
Simulation & Expertise
R&D & Start-up

LTG Aktiengesellschaft

Grenzstrasse 7
70435 Stuttgart
Germany
Tel.: +49 711 8201-0
Fax: +49 711 8201-720
E-Mail: info@LTG.net
www.LTG.net

LTG Incorporated

105 Corporate Drive, Suite E
Spartanburg, SC 29303
USA
Tel.: +1 864 599-6340
Fax: +1 864 599-6344
E-Mail: info@LTG-INC.net
www.LTG-INC.net